

Vanguard 1

rocketmantan.deviantart.com

#64

Maquette en papier
Paper model kit
Kartonmodellbausatz

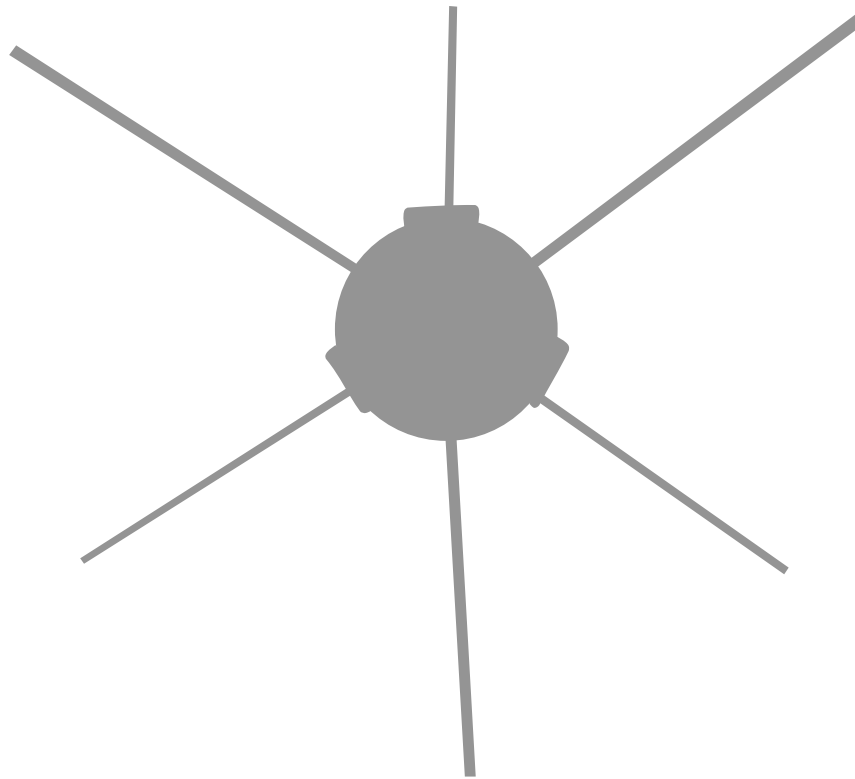

Vanguard 1 was the second spacecraft in Project Vanguard, the United States' response to Sputnik 1. The first mission in the series, Vanguard TV3, exploded on launch on December 6, 1957. The press later dubbed the mission as America's "Kaputnik". The incident became America's badge of shame, showing its utter inability to properly enter the space race. Over a month later, the US would finally enter space with Explorer 1, a project built separately from the Navy.

Built under the auspices of the U.S. Navy, Vanguard 1 was almost identical to her failed sister ship. The spacecraft housed two 108MHz transmitters, one powered by a mercury battery, the other by six solar cells. The transmitters were largely used for tracking purposes.

Vanguard 1 left the launchpad on March 17, 1958 at 12:15 UTC. It remains the oldest manmade satellite in orbit, having made approximately 228,000 orbits as of March 1, 2012.

VANGUARD 1

Table of Contents

If you purchased/downloaded this kit with the pages out of synch with the pdf (if this is even in pdf format), you might be a victim of software pirating. If that's the case, sucks to be you, sucks to be me.

Instructions	3
Parts	4
(Optional) Antennae	10

VANGUARD 1

Instructions

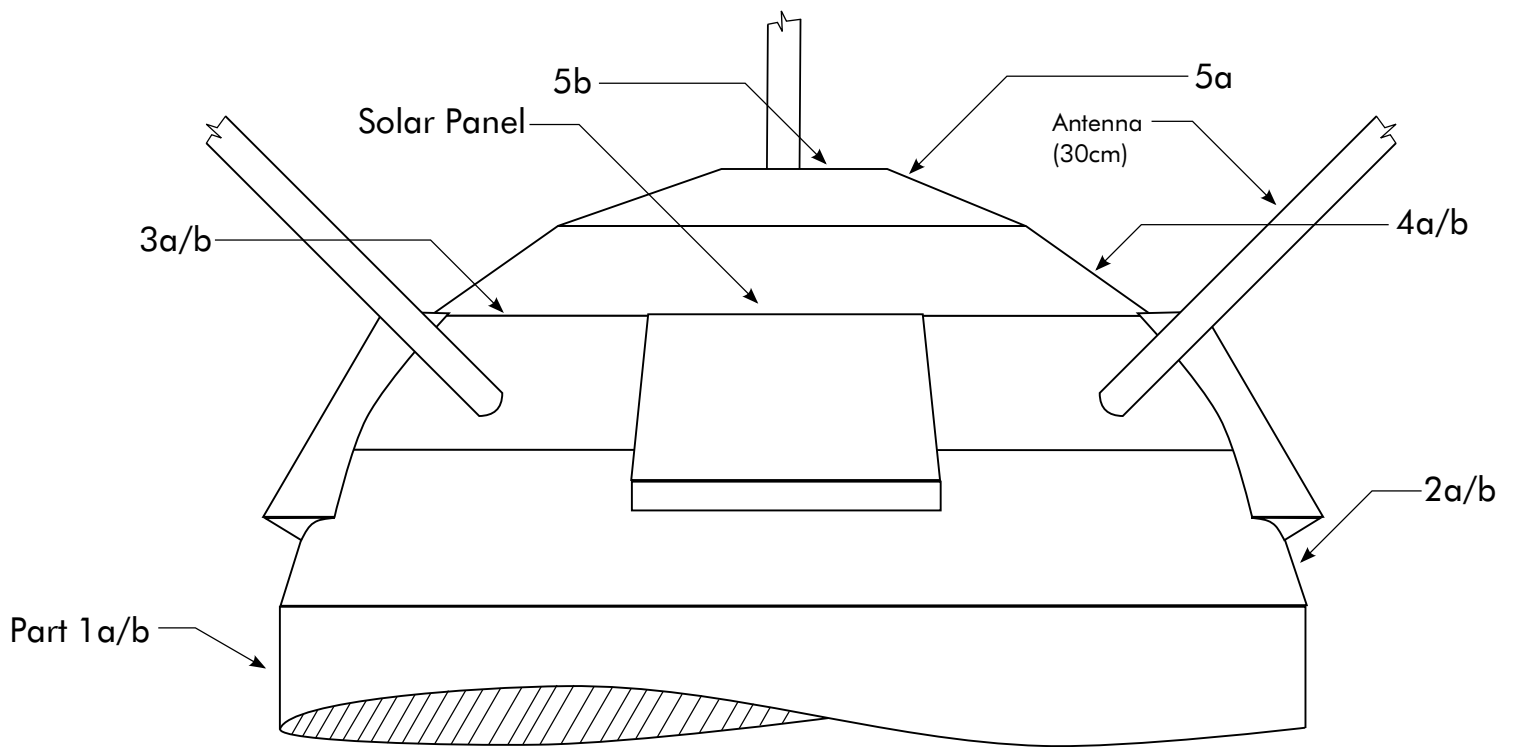

The model's pretty much symmetrical horizontally; follow the same layout for the bottom half. Make sure, however, that the antennae and solar panel positions are reversed on the bottom. i.e. if one of the top antennae is pointing right at you, its bottom-counterpart should be facing away from you.

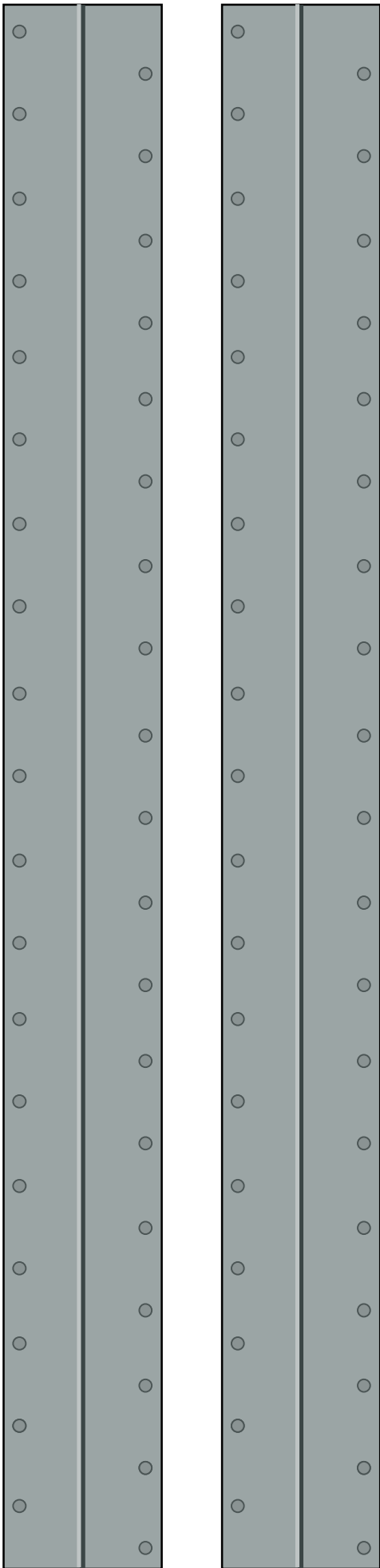

Spacecraft bus Parts 1a/b

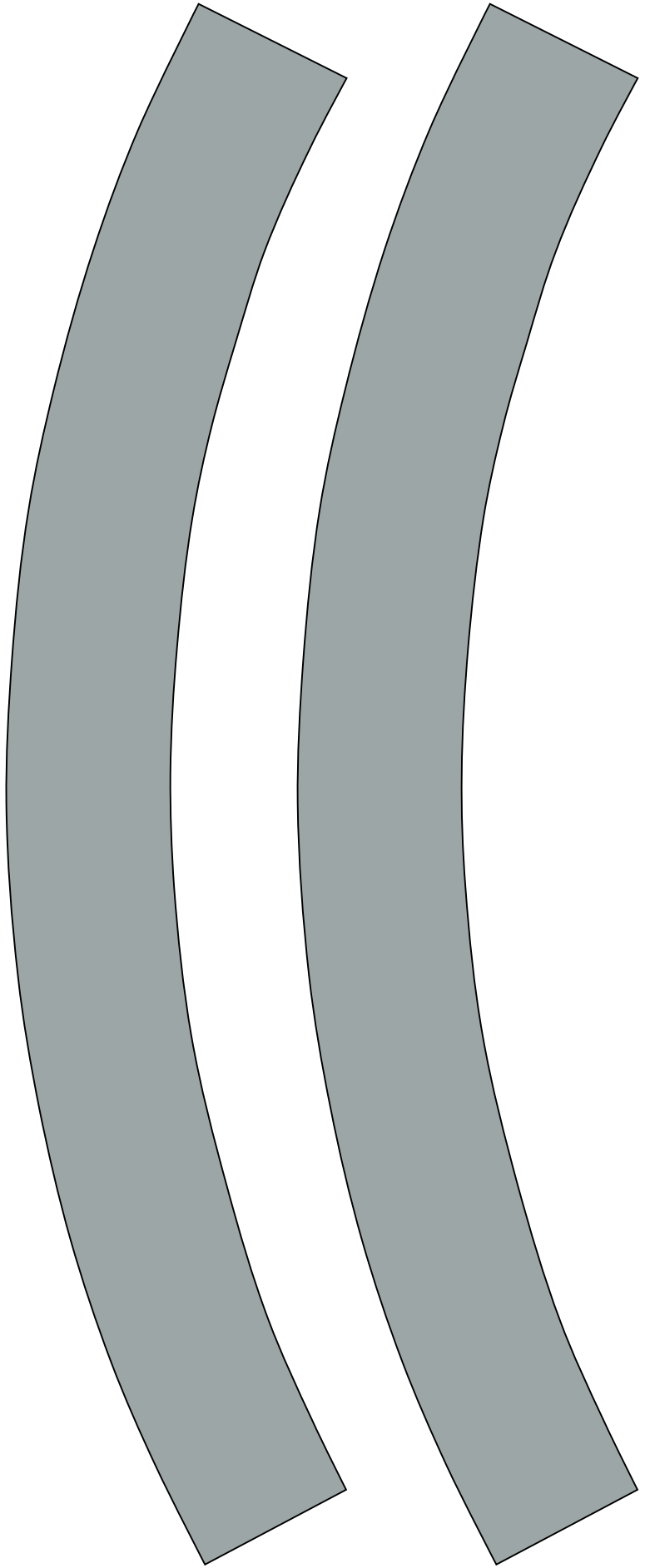

Parts 2a/b

This model is a symmetrical sphere, and therefore almost every part has an exact duplicate, hence the duped lettering.

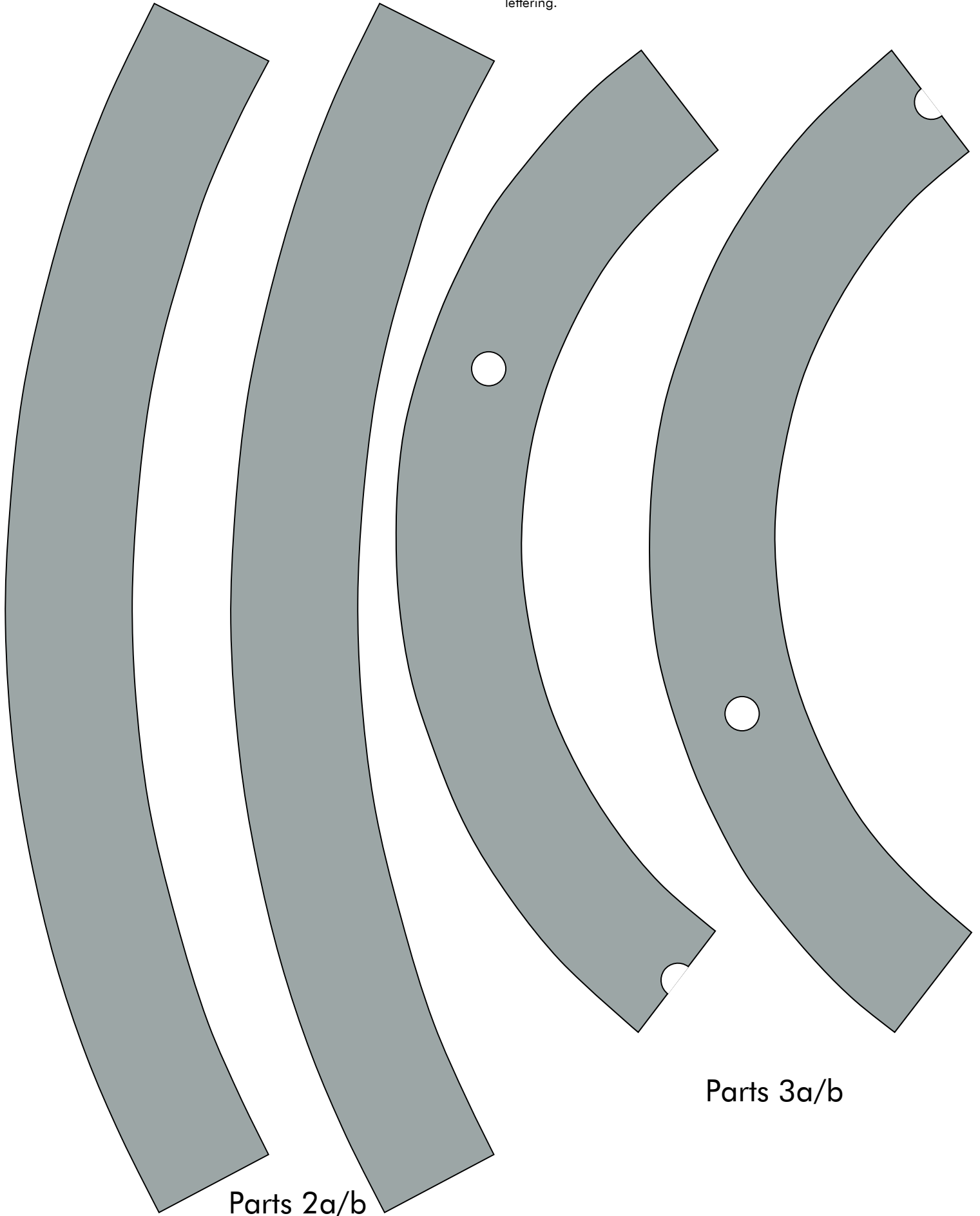

Parts 2a/b

Parts 3a/b

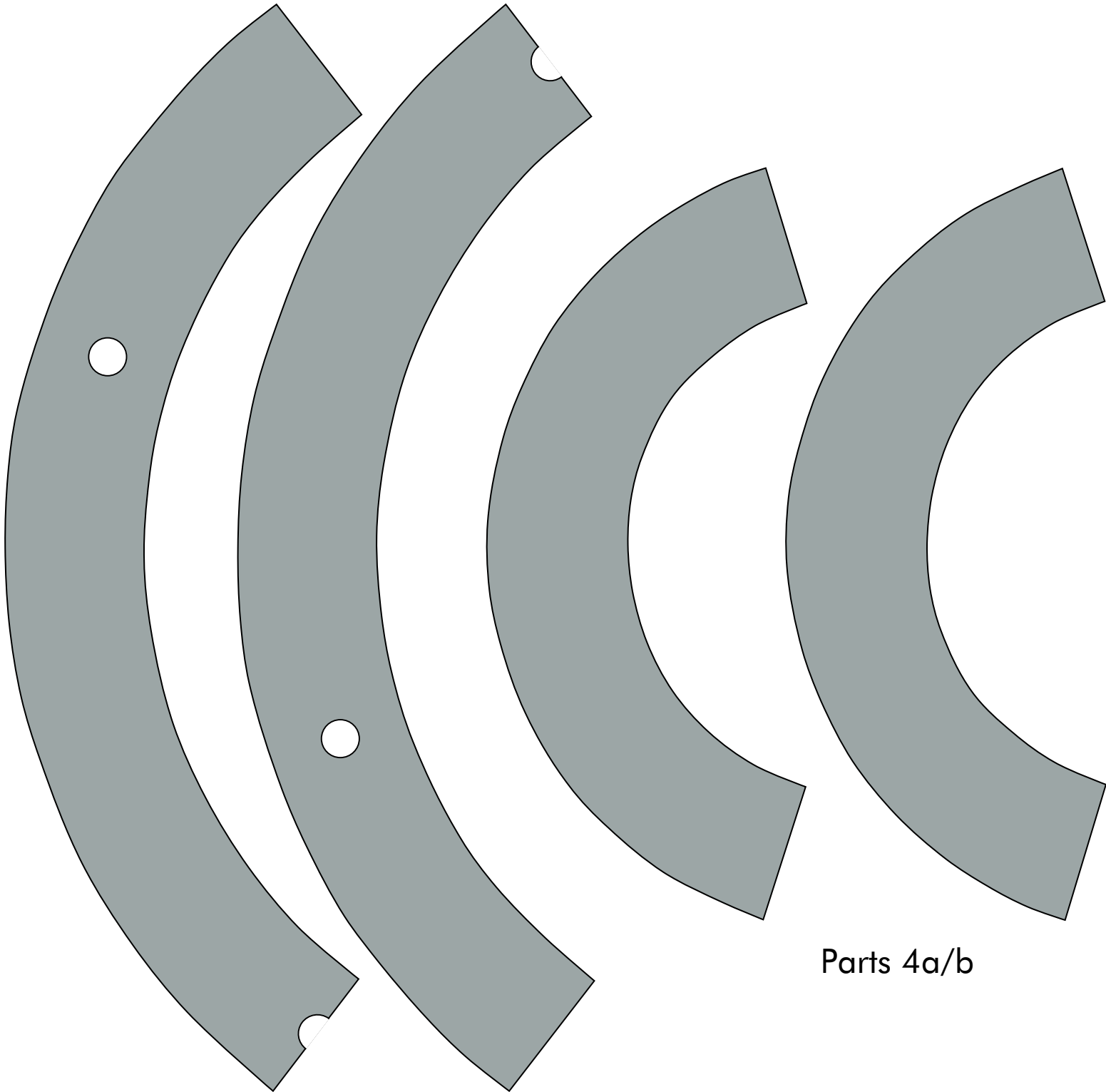

Parts 3a/b

Parts 4a/b

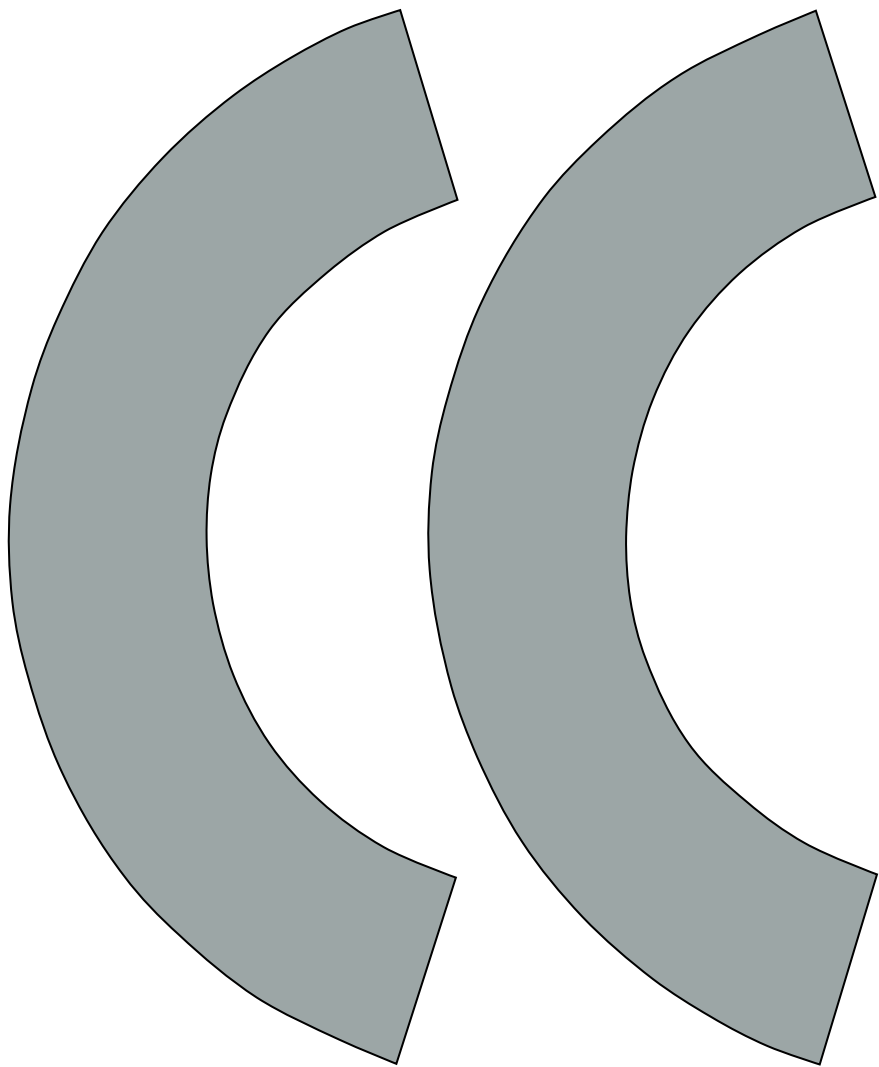

Parts 4a/b

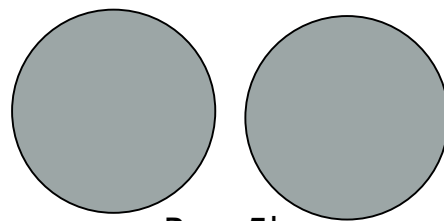

Part 5b

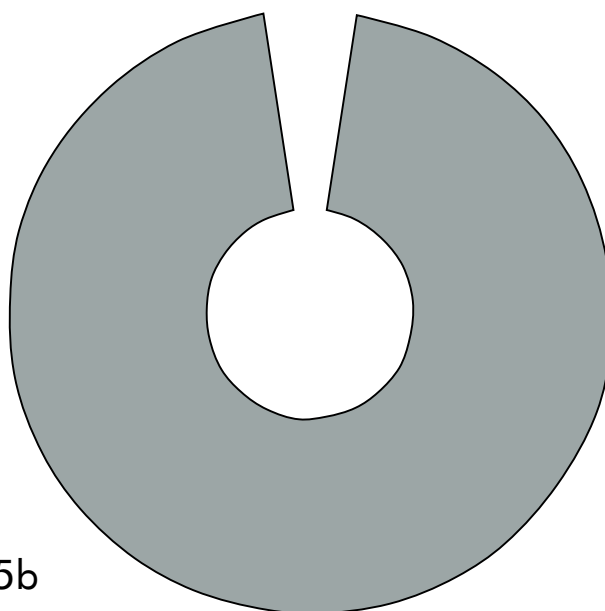
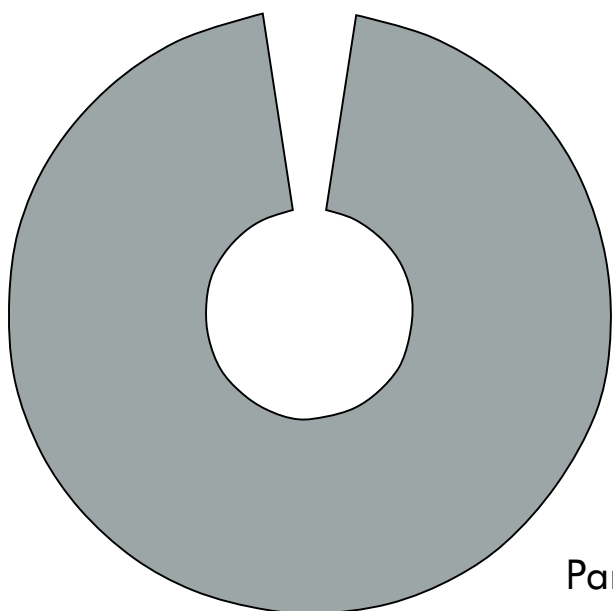

Part 5b

Solar Panels

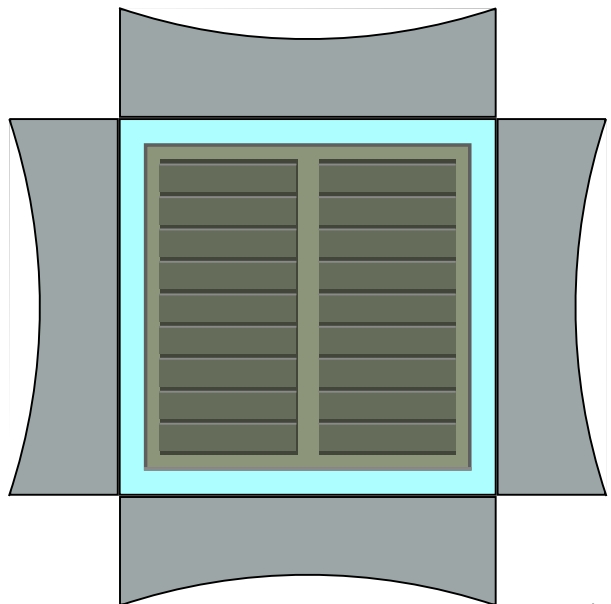
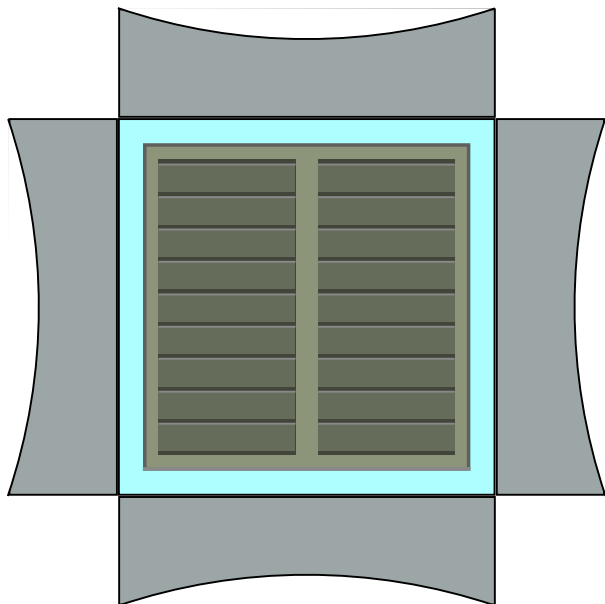
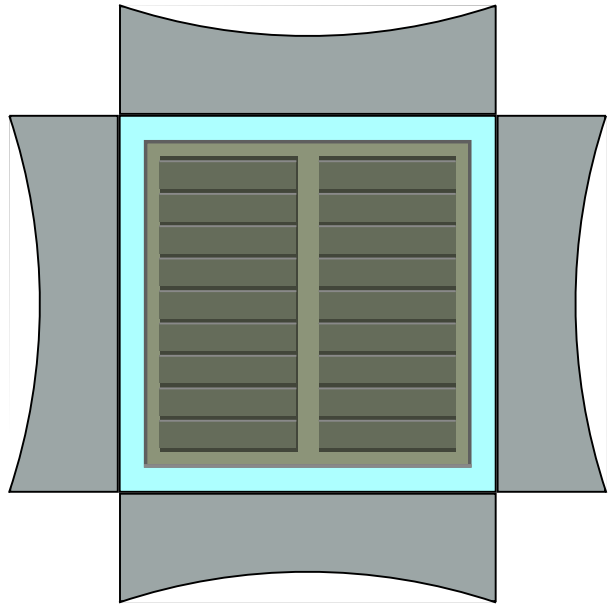
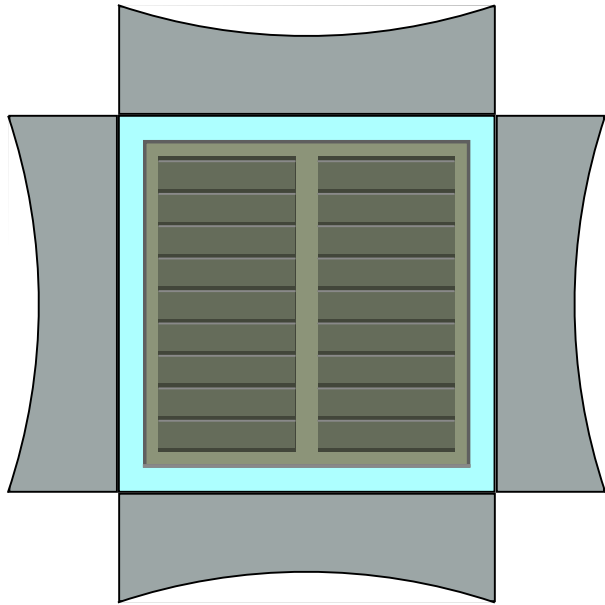
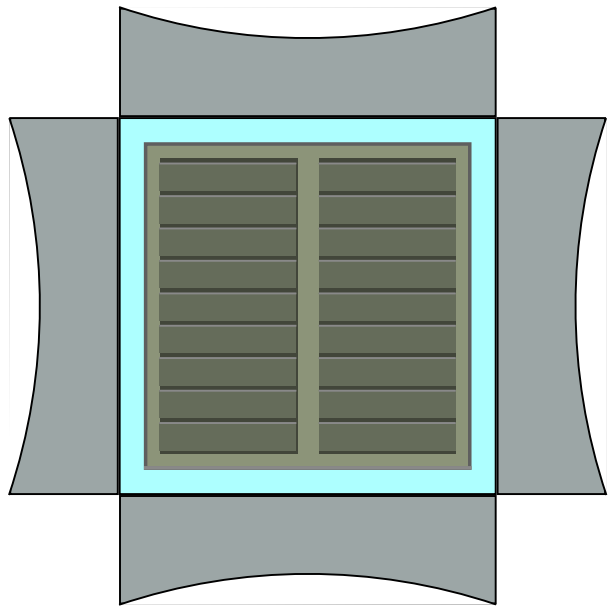
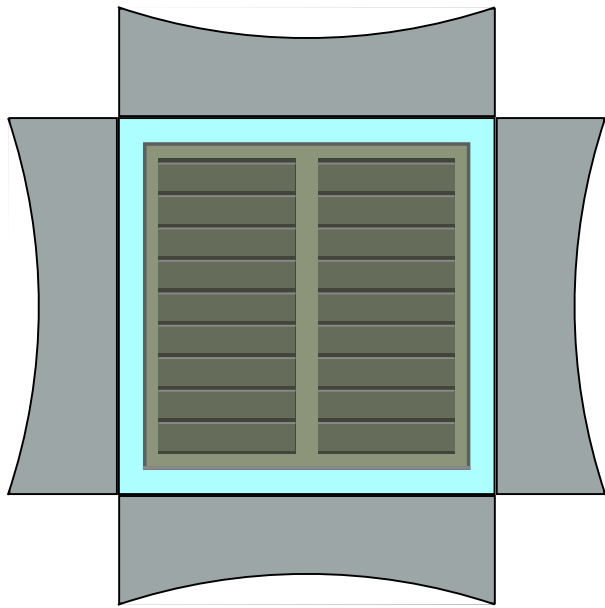

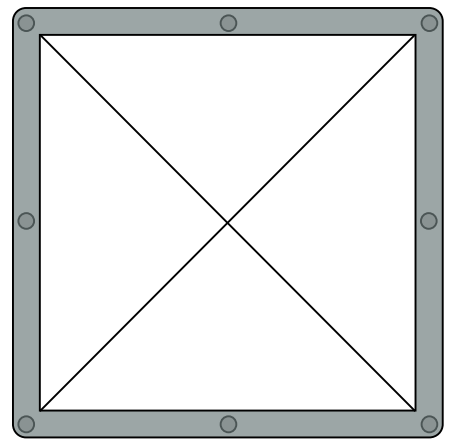
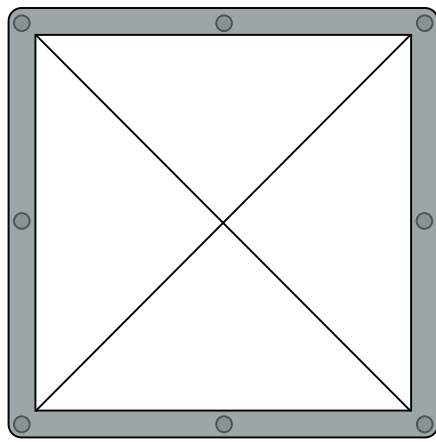
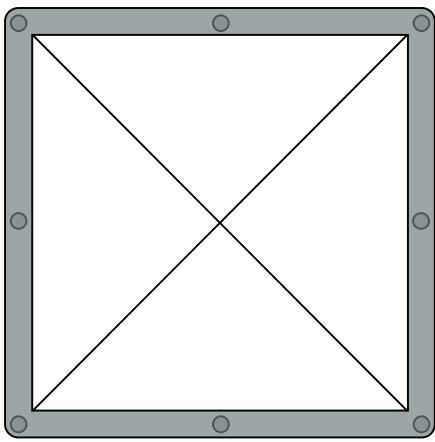

Solar Panel Fairings
(go on bottom of panels)

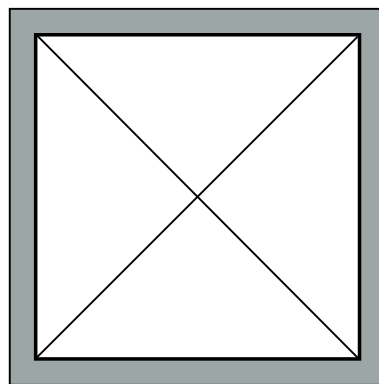
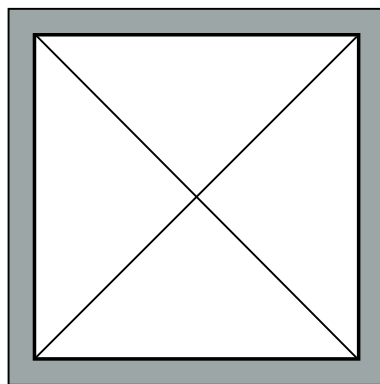
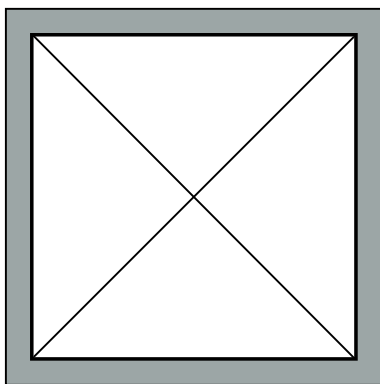
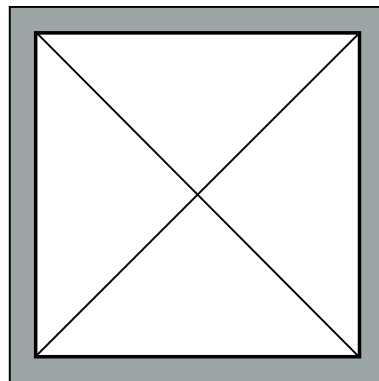
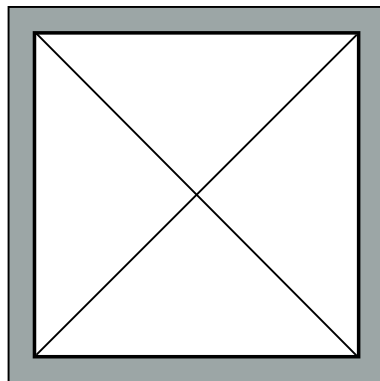
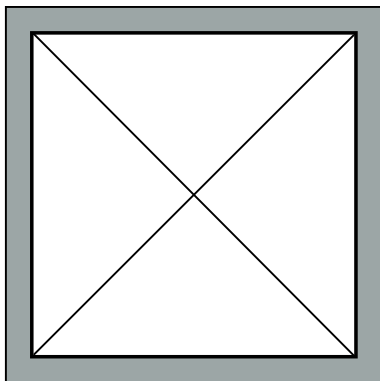
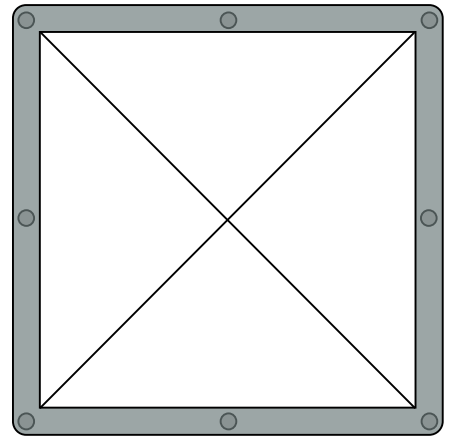
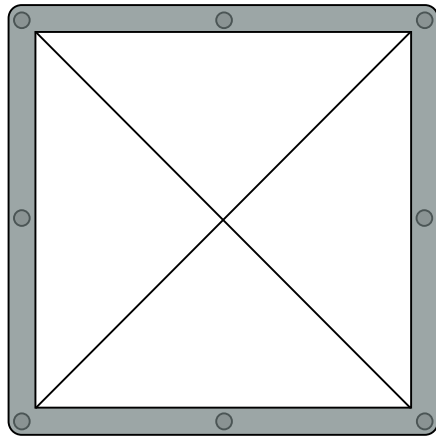
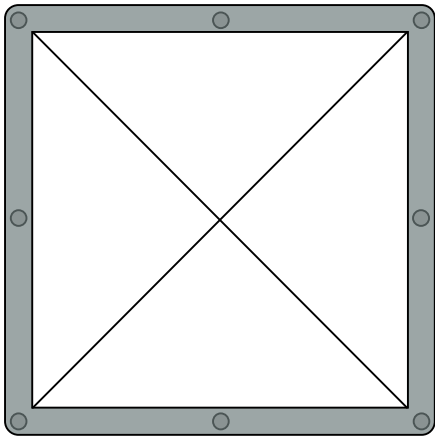

Panel frames go on top of the solar panels.

PROTIP:
Cut slits into the solar panel and sandwich a transparency between the frame and panel for added detail.

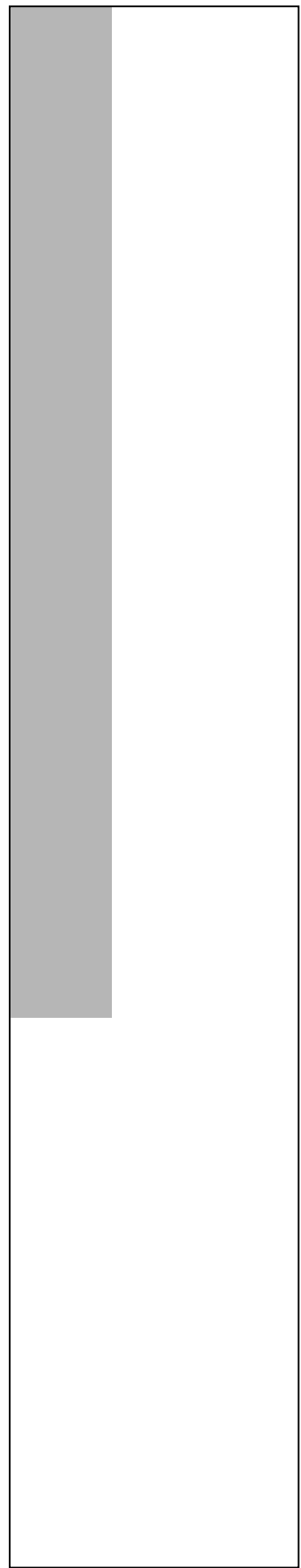
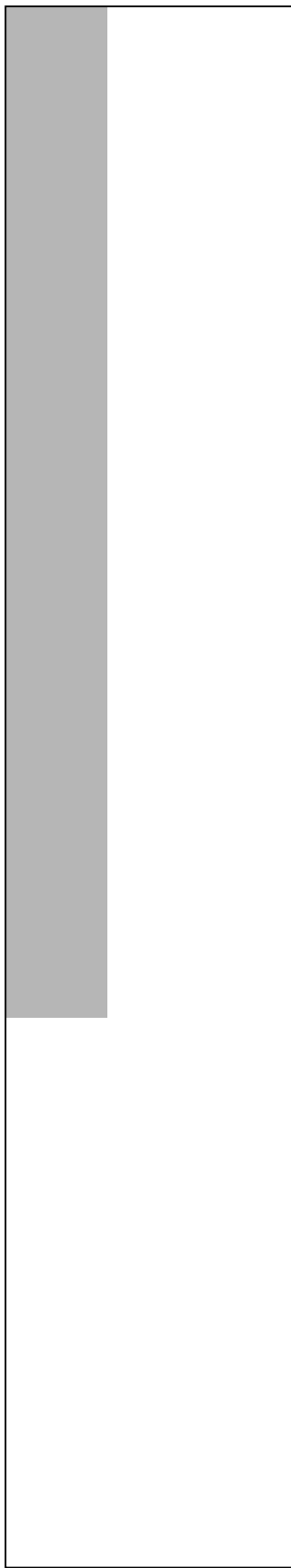
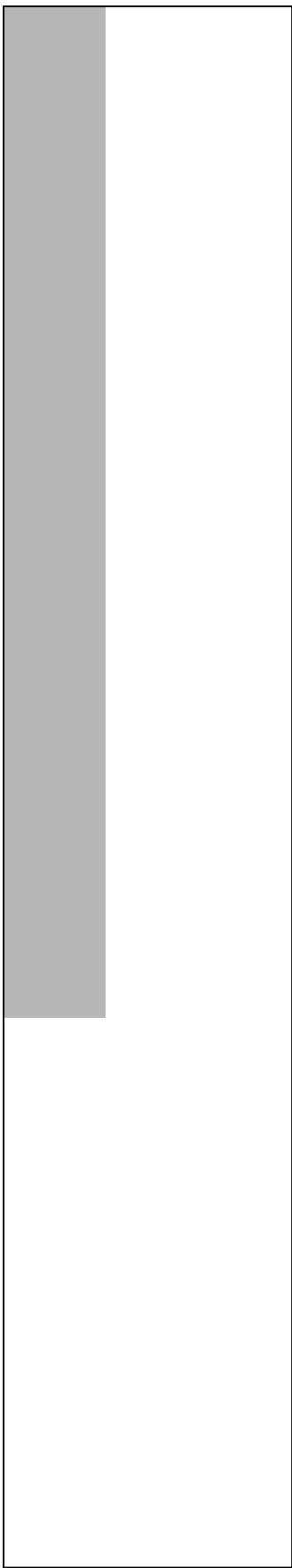

For those who don't have skewers at hand, here are some roll-up antennae. They're meant to be threaded through the whole sphere and out the other end.

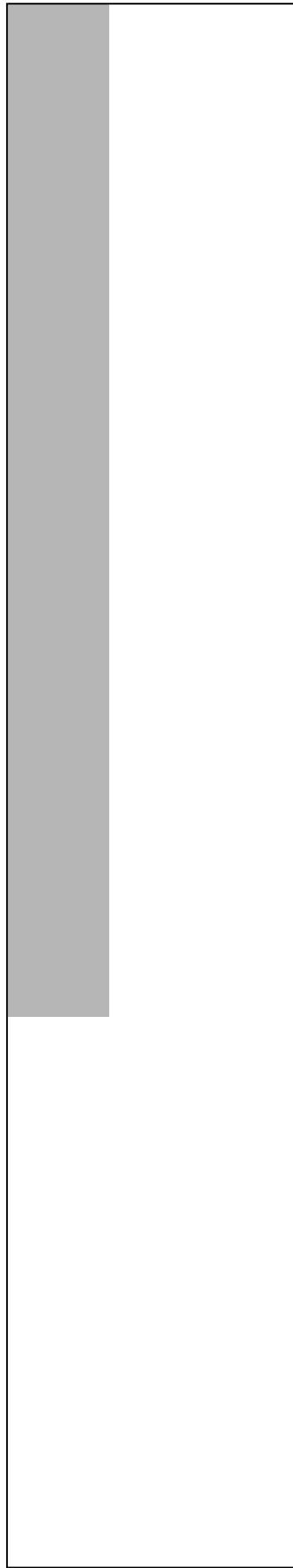
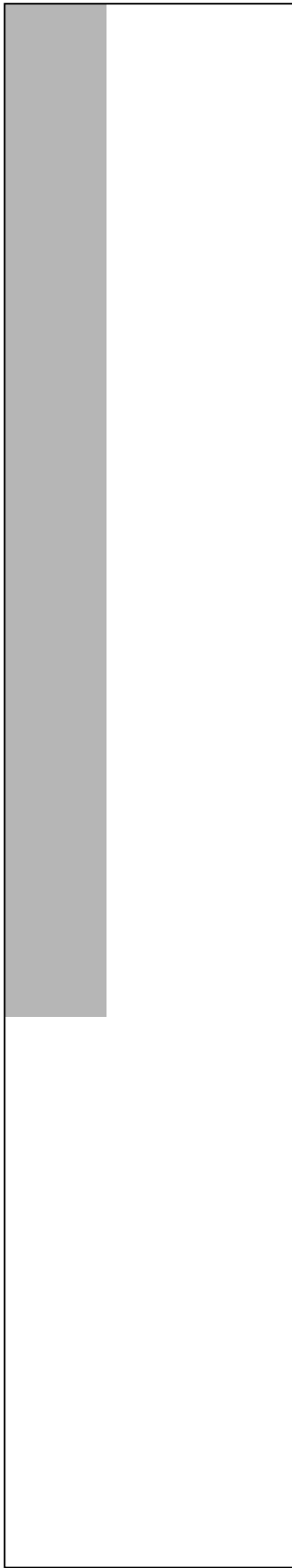
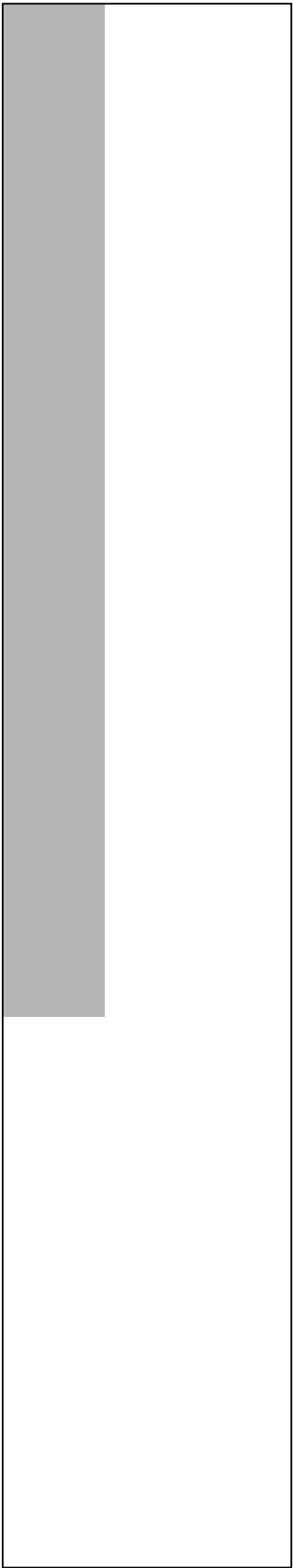

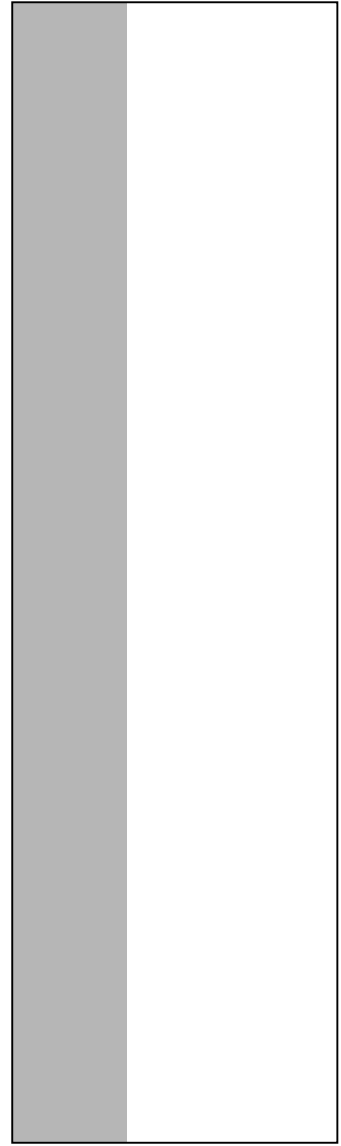
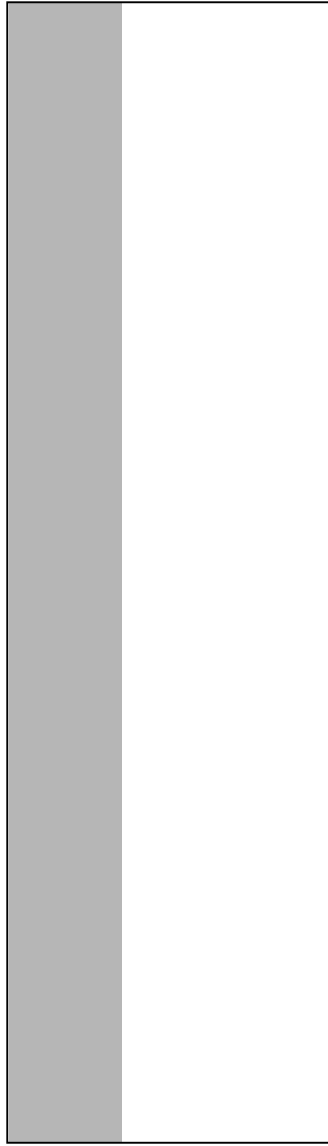
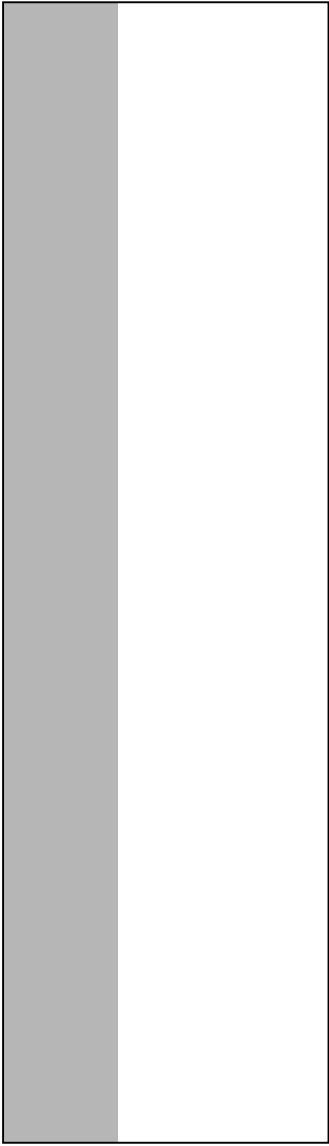

The antennae extended out 30cm from the sphere.
These are the antenna extensions.

